

BOOKMARKS

Instructions

Color in the outlines before you cut the design.

1. Use the marks to cut out the designs and fuzzy cut around the glasses
2. Score along the two center sides of the square.
3. Fold the white flap into the middle and apply glue to the stars or the entire flap.
4. Fold the flap with the glasses into the middle and glue to the other flap.

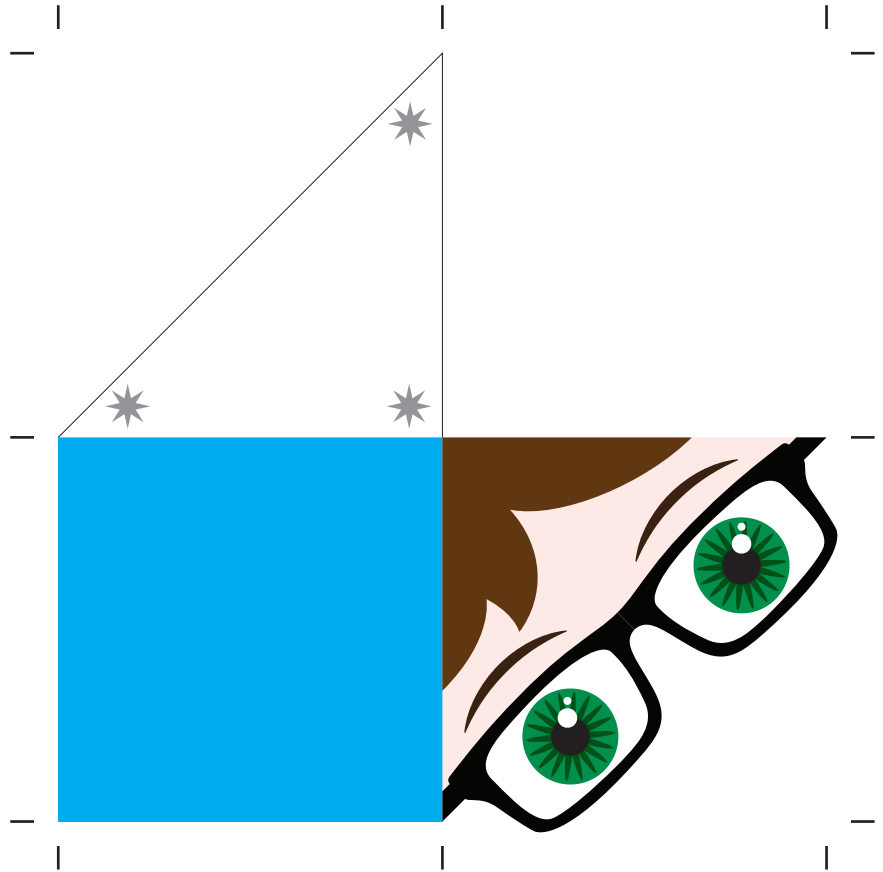

You can glue colored or patterned paper inside of the bookmark.

This can help make the bookmark more sturdy and can also add a nice accent.

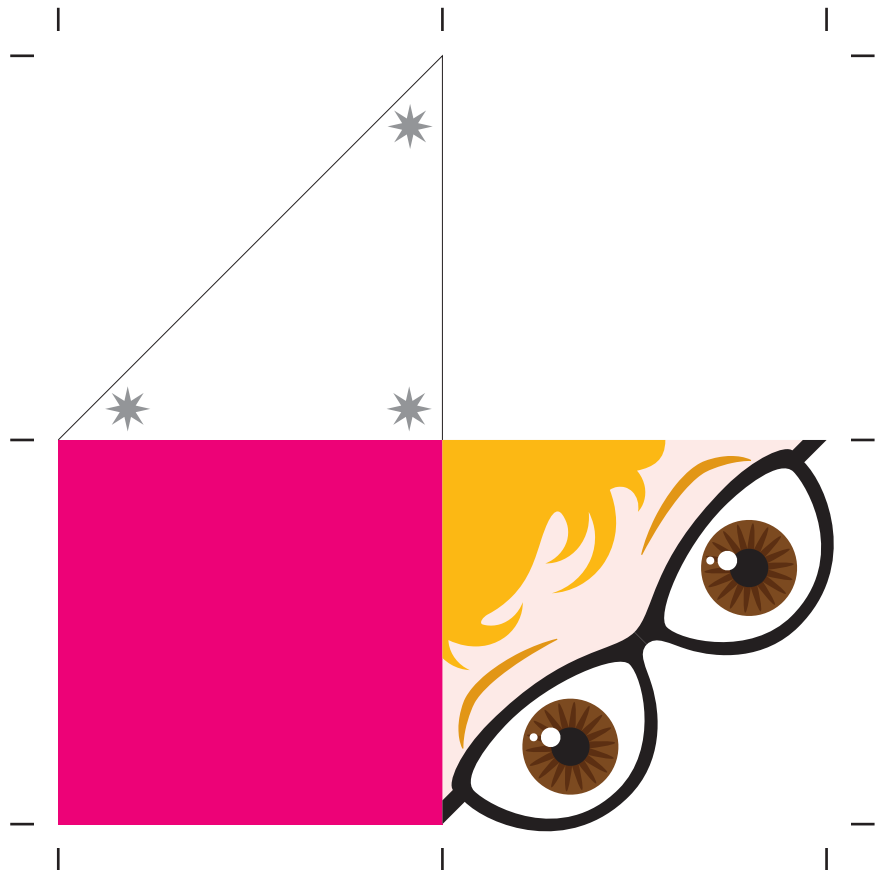

BOOKMARKS

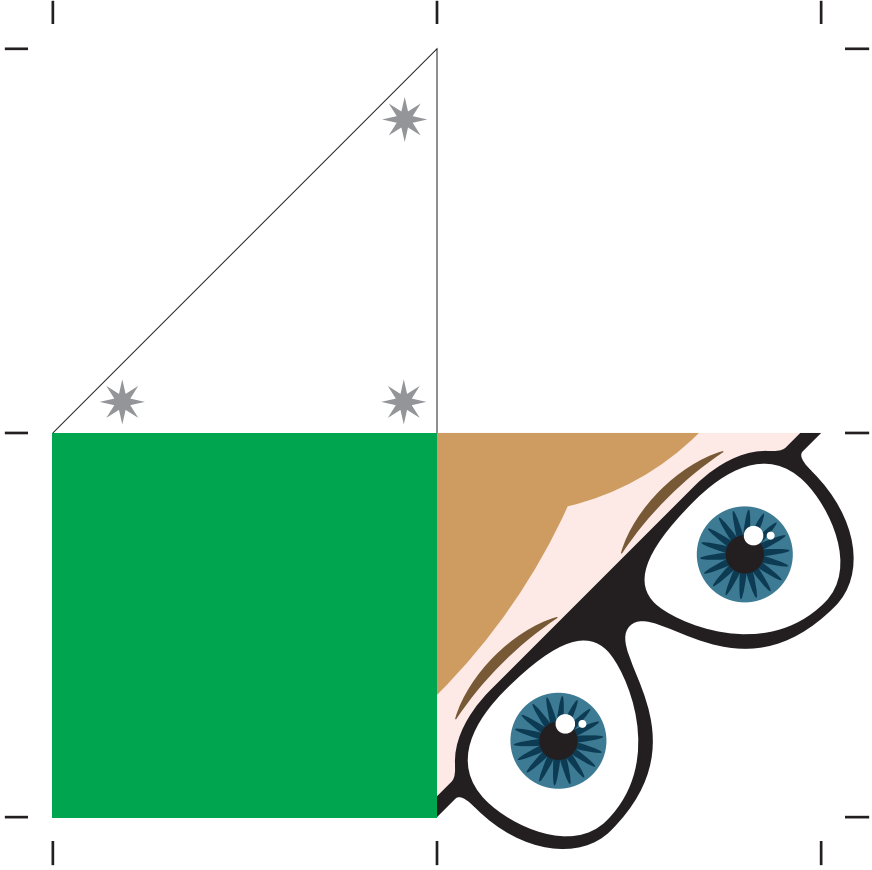
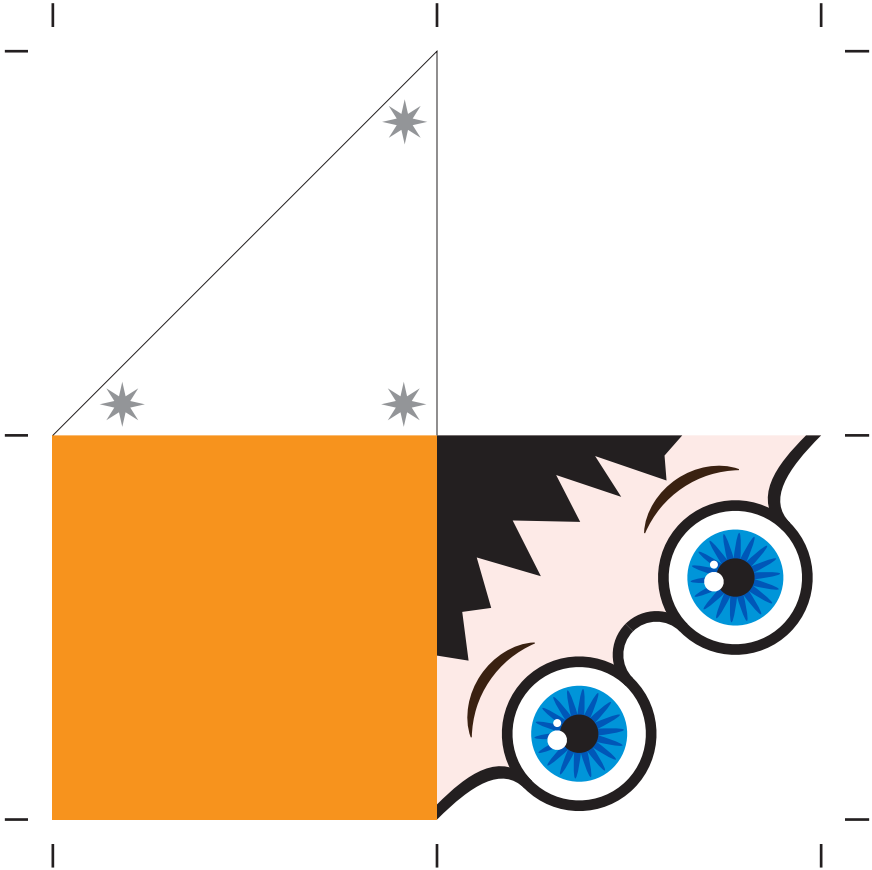

BOOKMARKS

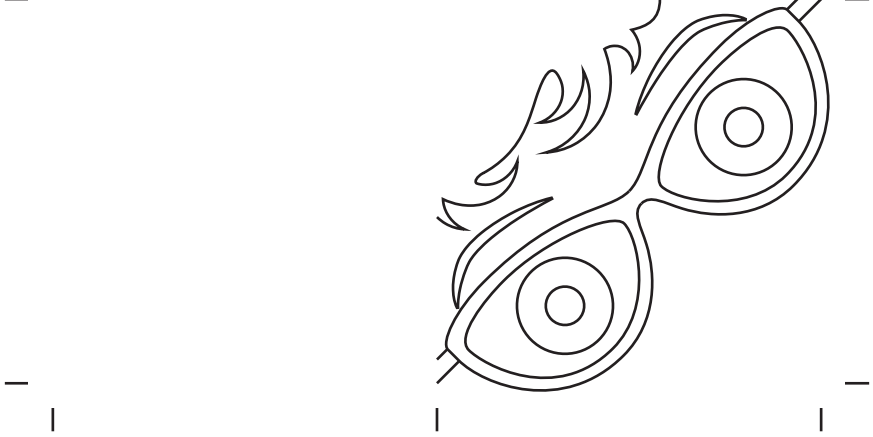
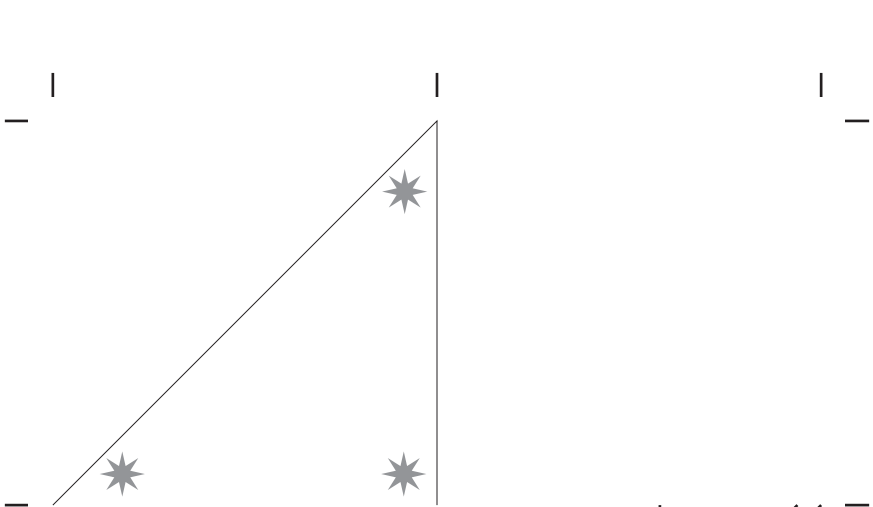
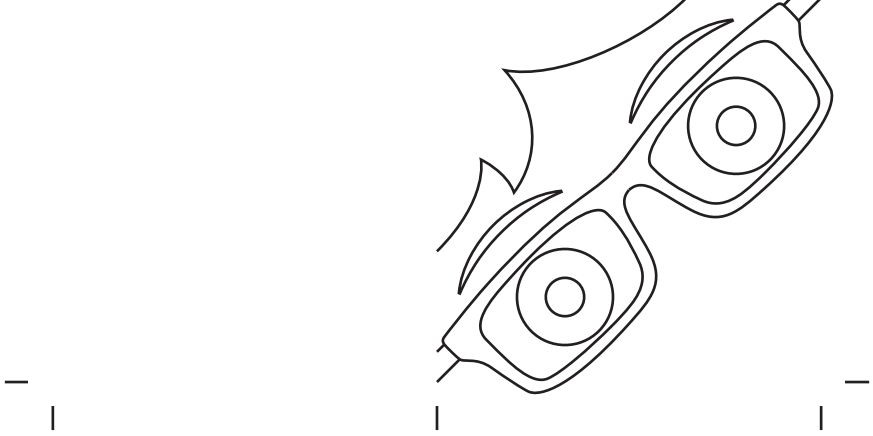
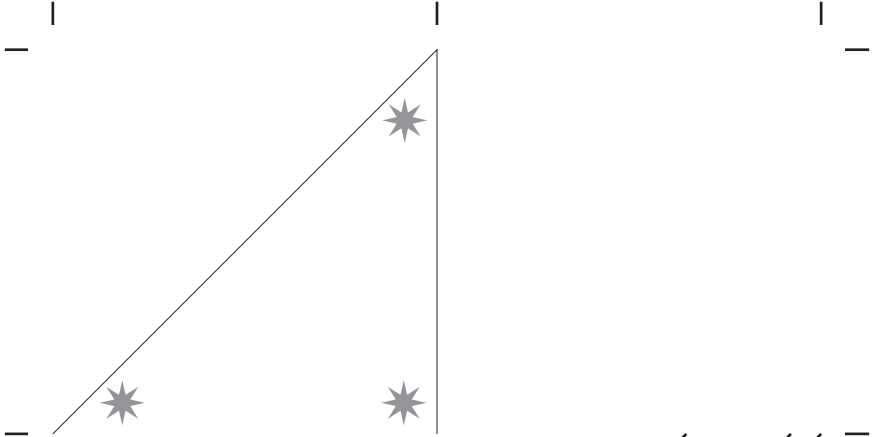

BOOKMARKS

